



LAMPO lighting designers

46042 Castel Goffredo - Mantova - Italy

Via Portogallo, 4

tel +39 0376 770869 fax +39 0376 780947

www.lamposrl.it

e-mail info@lamposrl sales@lamposrl

tech@lamposrl exp@lamposrl

ENGLISH

CEILING RGB



Recessed halogen colour changer

USER' S MANUAL release 1.0

This manual must be considered an integral part of the projector.

BEFORE CONNECTING AND USING THE PROJECTOR, IT IS IMPORTANT TO READ CAREFULLY ALL THE INSTRUCTIONS IN THIS MANUAL.

QUALIFIED PERSONNEL ONLY, IN COMPLIANCE WITH ALL THE SECURITY LAWS, CAN DO THE INSTALLATION, THE MAINTENANCE AND THE UTILISATION OF THIS PROJECTOR.

BEFORE CONNECTING THE PROJECTOR, MAKE SURE THAT THE FREQUENCY AND THE VOLTAGE VALUES ARE SUITABLE AS SPECIFIED ON THE PROJECTOR.

FOR ANY DOUBT, CONTACT YOUR SUPPLIER OR SEND AN E-MAIL TO:

tech@lamposrl.it

IP40 SOLID: Protected against solid object greater than 1mm
WATER: Not protected



Suitable for direct mounting on normally flammable surfaces



Minimum distance from lighted objects (meters)

ta 30 °C Rated maximum ambient temperature (indoor with ventilation)



Connection must be made to a power supply system fitted with efficient earthing (EN60598-1 – Class I fixture)

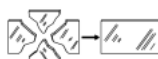

Replace any cracked protective shield, dichroic filter or lens

Index

Dimensions and weight	page 2
Technical data	page 2
Admissible environmental conditions	page 3
Storage	page 3
Example of installation	page 3
How many projector can I drive?	page 4
What is RGBW controller	page 4
Optical system	page 4
Lamp replacement	page 5
Spare parts	page 6

Dimensions & weight

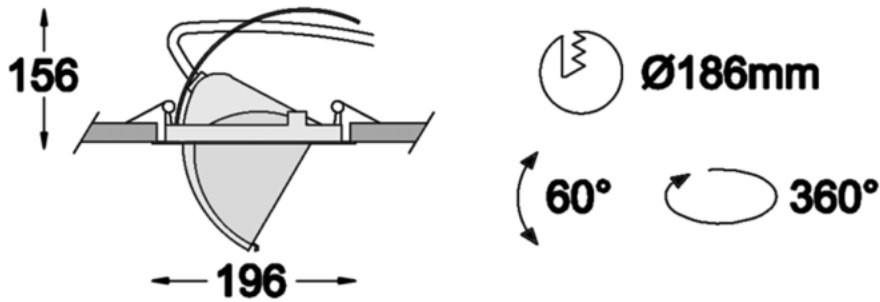

AS129 Ceiling RGB 3 lamps = 1 Kg

Technical data

- Aluminium body
- Protection rate IP40
- Adjustable fixing
- Ideal for distances between 2 and 5m
- Halogen Lamp 50W 230V long life - GU10 socket – (example: Osram HALOPAR, Philips TWISTline)
- 3 lamps version
- Colour changing system Red Green Blue (unlimited colours combination)

Ceiling RGB is without the electronics inside; it must be driven by a “RGBW Controller”

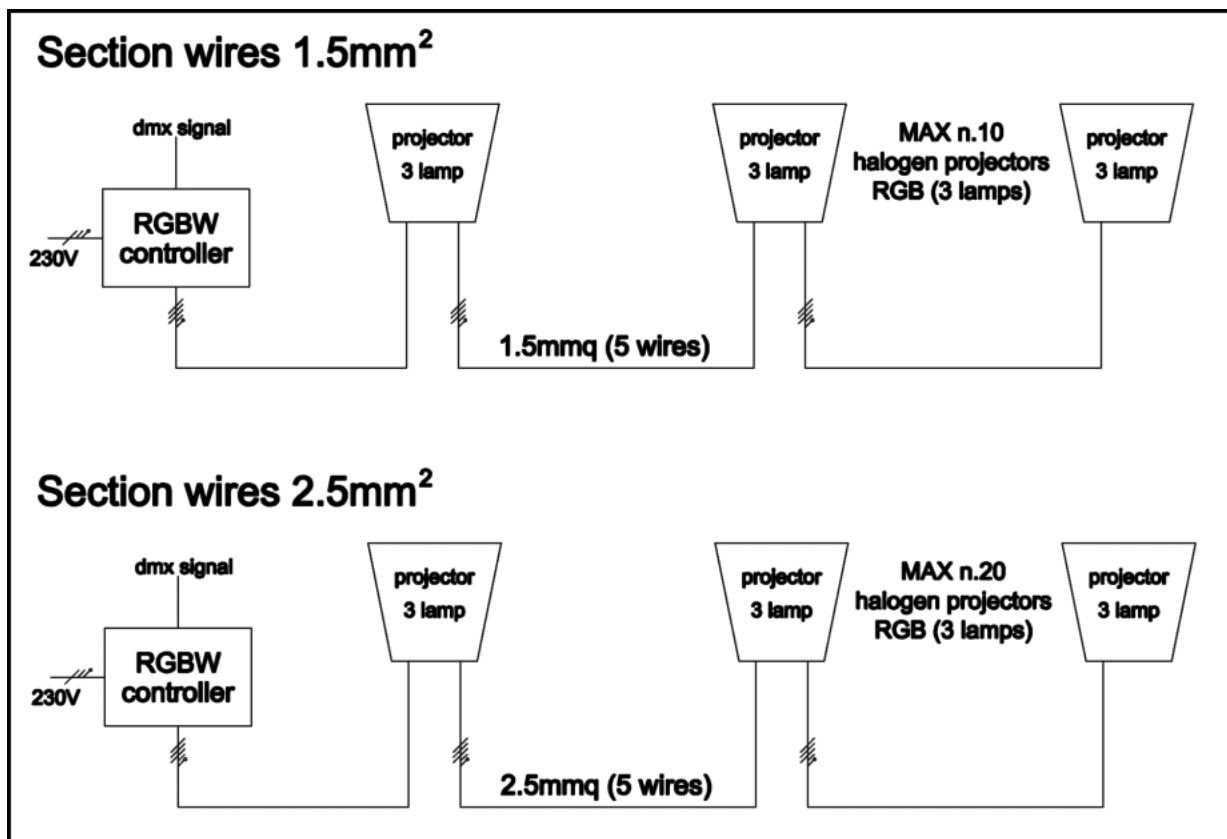

Admissible environmental conditions

The projector was engineered and produced to function in outdoor areas with an air temperature ranging between 0° and 35°C and with a humidity level between 30 and 90%.

When choosing the installation, please make sure that the device is not exposed to extreme heat or in small area.

Storage

The projector, in its original packing, must be kept in covered, dry areas with a temperature between -10°C and +50°C. Attention, the projector will be damaged during the unpacking.

Example of installation

The power unit of RGBW CONTROLLER drives a series of the CEILING RGB, 5 wires cable

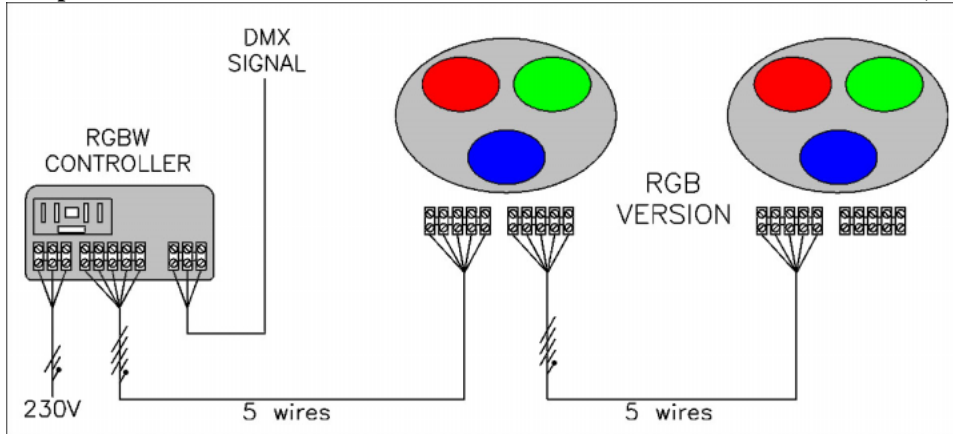

In the example RGBW CONTROLLER drives a series of Ceiling RGB on a STAND ALONE mode or on DMX (any standard DMX consol can control one or more RGBW controller).

Ceiling RGB has the terminal connection blocks (see the drawing)

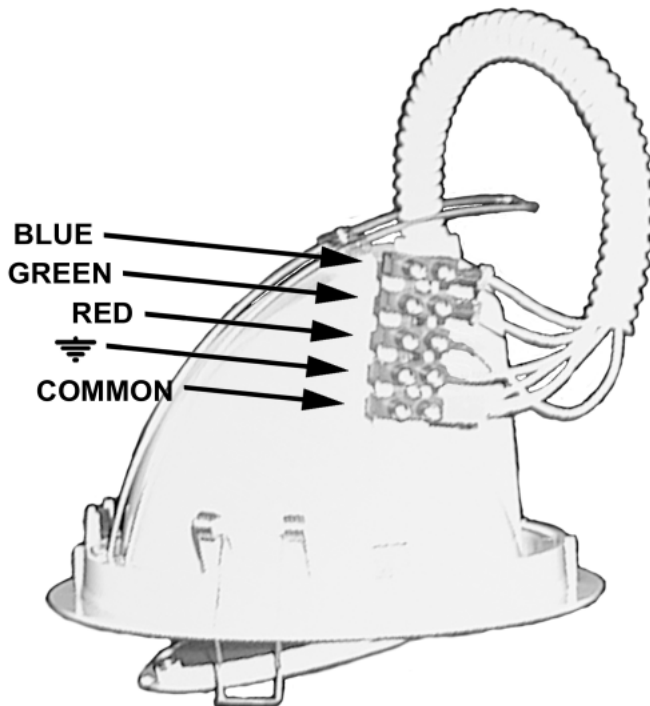

COMMON = NEUTRAL
 = **GROUND**
RED = RED Slight lamps
GREEN = GREEN Slight lamps
BLUE = BLUE Slight lamps
WHITE = WHITE Slight lamp

Do not change the wires sequence.

How many projector can I drive?

Using a series of projectors with section 1.5mmq cables, RGBW CONTROLLER can drive up to a maximum of 10 CEILING RGB 3 lamps.

Using a series of projectors with section 2.5mmq cables, RGBW CONTROLLER can drive up to a maximum of 20 CEILING RGB 3 lamps.

The series of Ceiling driven by RGBW controller execute the same colour simultaneously.

Do not use standard dimmers to drive the projector.

Do not change the wires sequence.

What is the RGBW CONTROLLER?

RGBW CONTROLLER, it is a unit that can control a series of halogen projectors. To order this unit it is necessary specify if the projectors are with 3, 4 or 8 lamps, to have the correct software.

RGBW CONTROLLER is available with DIN45 fasting (for switch board), or inside an IP65 metal box (all indoor and outdoor application).

RGBW CONTROLLER can work on stand alone mode or on DMX (with dmx consol).

Optical system

Ceiling RGB have a very wide soft beam.

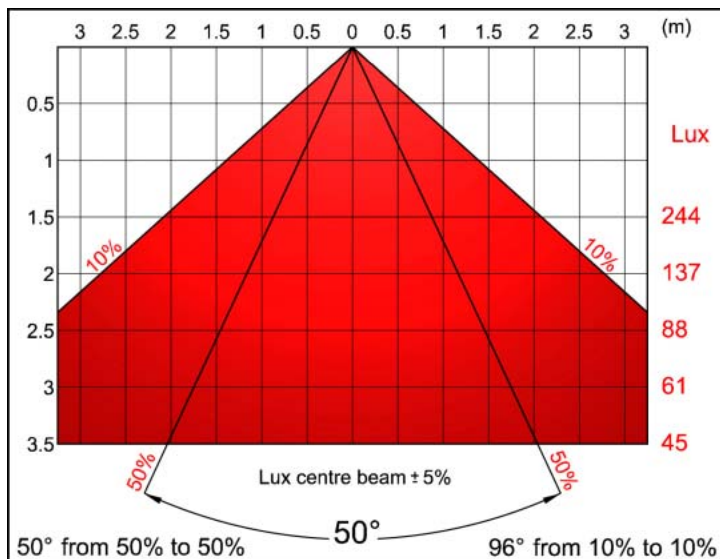

The diffuser filter, increasing the beam angle and mixing the primary colours.

Lamp replacement

Disconnect the projector from the main power supply!



Unscrew the 2 screws that hold the colours holder.

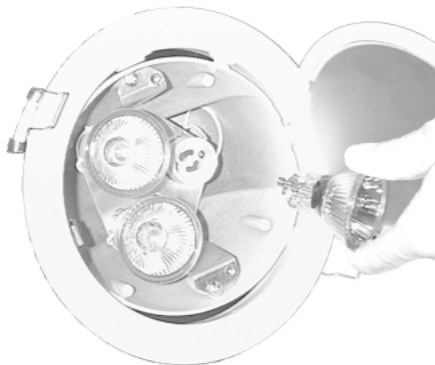

Remove the lamp, taking care to wear proper protective gloves.

Insert a new lamp.

Re-insert the colours holder.

Fix well the 2 screws that hold the colours holder.



Use only 230V GU10 50W halogen lamps.

**HALOGEN LAMPS CONTAIN SUBSTANCES THAT CAN POLLUTE THE AMBIENCE.
DISPOSE OF USING THE APPROPRIATE REFUGES (TOXIC).**

Spare parts

When ordering spare parts for the projector remember to mention the model and serial number which can be found on the plate at the rear of the projector.

Call your area dealer or feel free to contact the manufacturer for any additional assistance.

SPARE PART LIST

CODE	DESCRIPTION
LP144	Halogen lamp, 230V 50W, GU10 socket

The improper use of this projector, cancel the guarantee and our responsibility. All the information have been written and driven with extreme care; however, we do not engage us any responsibility for contingent errors or omissions. We reserve the right to modify and/ or improve our product as we retain necessary, without subsequent warning or notice. It is forbidden any complete or partial reproduction of this handbook, if not expressly authorized.